



atmosphera®  
Créateur d'intérieur







---

## SLANO

REF. 184909MOD



 x 1

 ①x 1	 ②x 2	 ③x 2	 Ax8	 Bx8	 Cx1
--	---	---	--	--	--

**1**

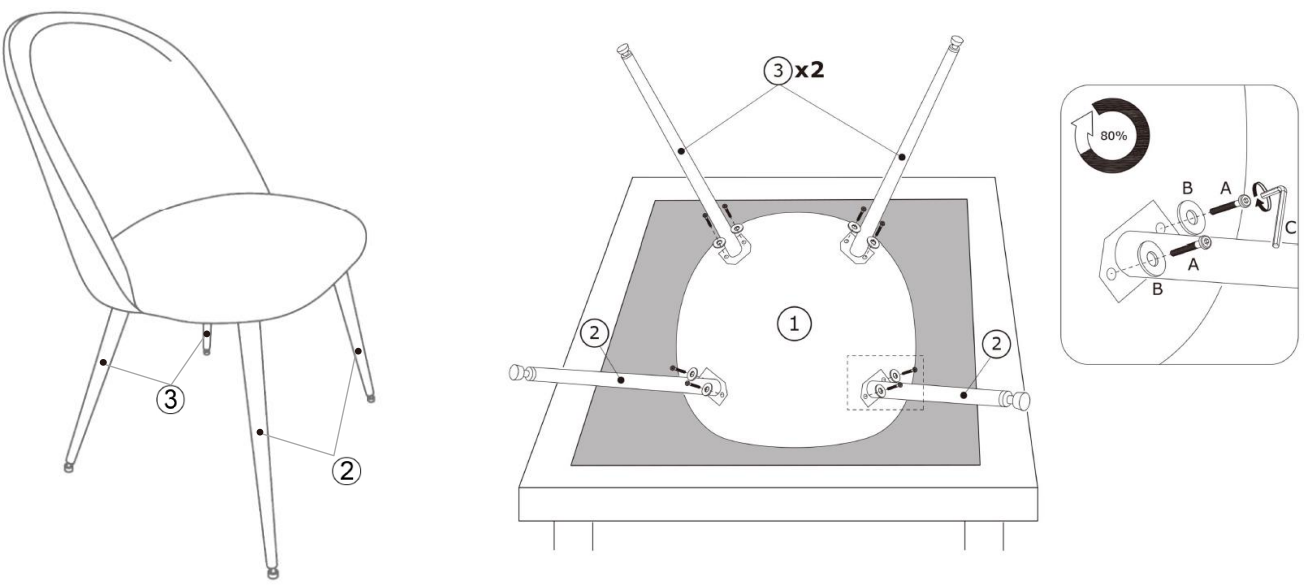

Diagram 1 illustrates the first assembly step. On the left, a side view of the chair shows the seat (1) and legs (2) being attached. The middle diagram shows the seat (1) being secured to the base with screws (2) and (3). The right diagram shows a detail of the seat attachment mechanism, indicating an 80% rotation and labels A, B, and C.

**2**

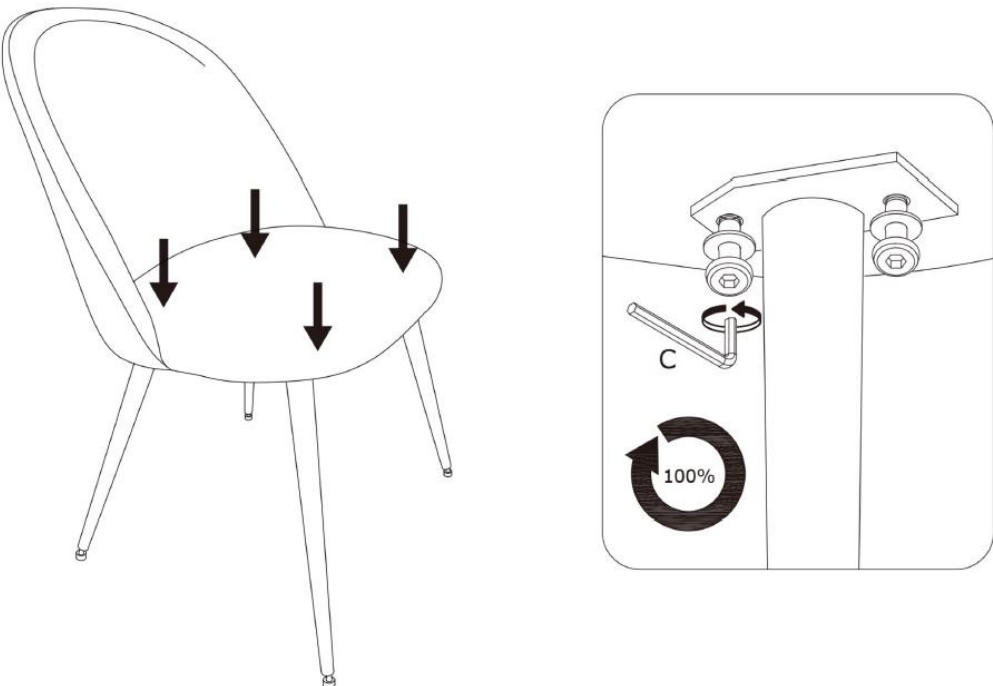

Diagram 2 illustrates the second assembly step. On the left, a side view of the chair shows the seat (1) being secured to the base with arrows pointing down, indicating the final tightening. The right diagram shows a detail of the seat attachment mechanism, indicating a 100% rotation and label C.



## FRANCAIS

**IMPORTANT** : A lire attentivement. A conserver pour consultation ultérieure.

**Installation** : A monter et/ou à installer par un adulte.

**Utilisation** : Produit à usage domestique. Usage intérieur exclusivement.

**Entretien** : Essuyer avec un chiffon humide. Terminer en essuyant avec un chiffon sec

## ENGLISH

**IMPORTANT** : Retain for future reference, read carefully.

**Installation** : To be assembled and / or installed by an adult.

**Use** : Product for domestic use. Indoor use only.

**Maintenance and cleaning** : Wipe with a damp cloth. Finish by wiping with a dry cloth.

## DEUTSCH

**WICHTIGE** : Informationen, aufmerksam durchlesen und aufbewahren.

**Installation** : Von einem Erwachsenen aufzubauen oder zu installieren.

**Verwendung** : Für den Hausgebrauch. Innenverwendung.

**Wartung und reinigung** : Mit einem sanftem Reinigungsmittel angefeuchteten Lumpe abtrocknen. Beenden, mit einem trocknen Lumpen.

## ESPAÑOL

**IMPORTANTE** : Guardar esta informacion para futuras referencias, leer atentamente.

**Instalacion** : Debe montarse o ser instalado por un adulto.

**Uso** : Producto de uso domestico. Uso interior.

**Mantenimiento y limpieza** : Secar con un trapo húmedo. Acabar secando con un trapo.

## PORTUGUÊS

**IMPORTANTE** : Informação a conservar, ler atentamente.

**Instalação** : Para ser montado ou instalado por um adulto.

**Uso** : Produto à uso doméstico. Uso interior.

**Manutenção e limpeza** : Use um pano úmido. Limpe em seguida com um coágulo seco.

## ITALIANO

**IMPORTANTI** : informazioni, conservare per futura consultazione, leggere con attenzione.

**Installazione** : Il montaggio o l'installazione devono essere eseguiti da un adulto

**Uso** : Prodotto per uso domestico. Usare unicamente all'interno.

**Manutenzione E Pulizia** : Utilizzare un panno umido. Asciugare con un panno asciutto.

## NEDERLANDS

**BELANGRIJKE** : informatie, bewaren voor toekomstig gebruik, zorgvuldig lezen.

**Installatie** : Te monteren of installeren door een volwassene

**Gebruik** : Product voor huishoudelijk gebruik. Alleen voor gebruik binnen.

**Onderhoud En Reiniging** : Met een vochtige doek schoonmaken. Op het einde afdrogen met een droge doek.

## РУССКИЙ

**ВАЖНАЯ** : информация, сохранять для использования в дальнейшем, внимательно прочесть.

**Установка** : Предназначены для монтажа или установки только взрослыми.

**Использование** : Изделия для домашнего использования. Только для использования в помещении.

**Обслуживание И Чистка** : Протрите влажной тряпкой, затем вытрите сухой тряпкой.

## POLSKI

**WAŻNE**: Przed użyciem przeczytaj ulotkę. zachowaj ją na przyszłość

**Montaż**: Do montażu lub instalacji przez osobę dorosłą.

**Użycie**: Produkt gospodarstwa domowego. Tylko do użytku w pomieszczeniach

**Instrukcje pielęgnacji**: Czyść czystą wodą lub szmatką zwilżoną w wodzie. Wytrzyj suchą szmatką



Retrouvez nous sur  
[atmosphera.com](https://atmosphera.com)

